

II Jornada dels Equips Tècnics de Menors:
Assessorament, Mediació/Reparació i Atenció a la Víctima.
Resiliència en víctimes i menors infractors

El genograma: actualització i unificació de la representació a l'informe

**Núria Esport Faixa, treballadora social de l'Equip Tècnic
de Menors (ETM) de Barcelona**

Olga Peret Gasia, treballadora social de l'ETM de Barcelona



25 de novembre de 2016







Avís legal

Aquesta obra està subjecta a una llicència Reconeixement 3.0 de Creative Commons. Se'n permet la reproducció, la distribució, la comunicació del material sempre que se citi l'autoria del material i el Centre d'Estudis Jurídics i Formació Especialitzada (Departament de Justícia) i no se'n faci un ús comercial ni es transformi per generar obres derivades. La llicència Reconeixement-No comercial-Sense obres derivades es pot consultar a <http://creativecommons.org/licenses/by-nc-nd/3.0/es/deed.ca>

Símbols per representar les persones

 Dona  (Ego)  Difunta

 Home  (Ego)  Difunt

 Transexual; home nascut dona

 Transexual; dona nascuda home

 n Altres fills/es; n = nombre de persones a representar

 Embaràs  Avortament

Relacions de parella (I)

 Parella (matrimoni civil o religiós, parella de fet, LAT)

 Relació extraconjugal

 Separació o divorci



Relacions de parella (II)

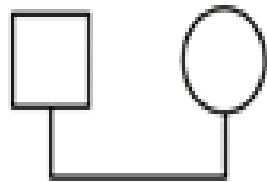

Parella heterosexual

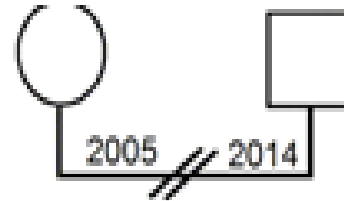

Parella iniciada l'any 2005 i separada el 2014

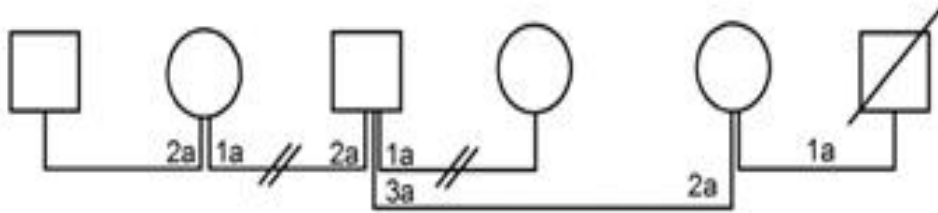

Parelles successives
(el núm. indica l'ordre)



Puzzle, familia, padre, madre, los niños
Geralt CC BY-ND 2.0

Relacions de parella (III)

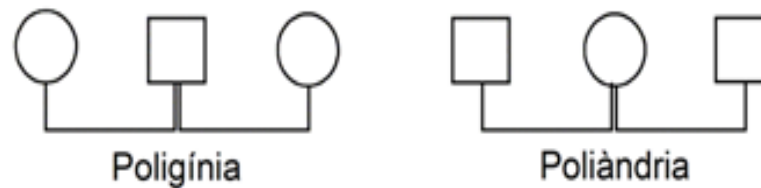
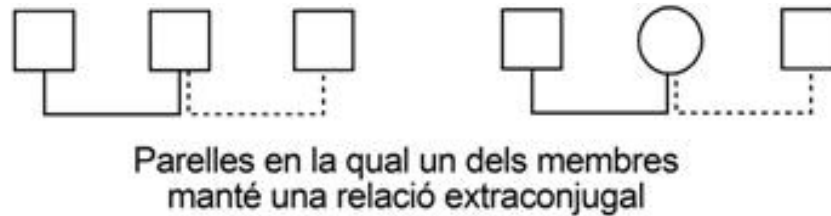
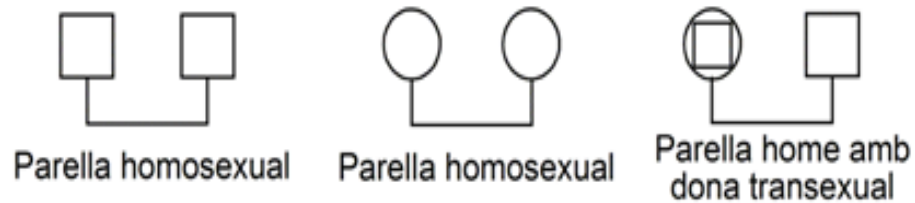

Relacions de filiació i parentiu (I)



Modern family en Netflix
Inetflix CC BY-ND 2.0

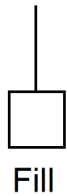

Fill



Filla

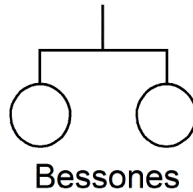

Bessones

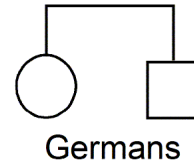

Germans

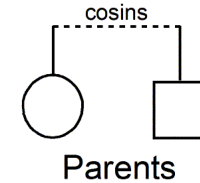

Parents

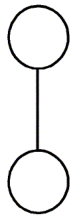

Mare sola
amb filla

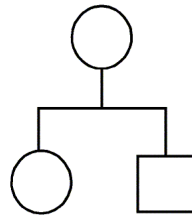

Mare sola
amb fills

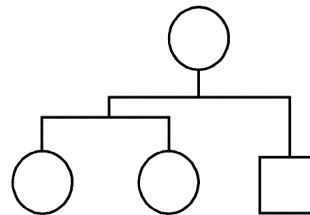

Mare sola
amb fills

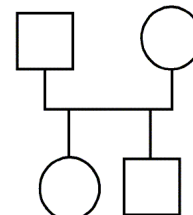

Parella heterosexual
amb fills

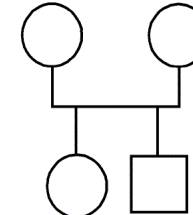

Parella homosexual
amb fills

Relacions de filiació i parentiu (II)

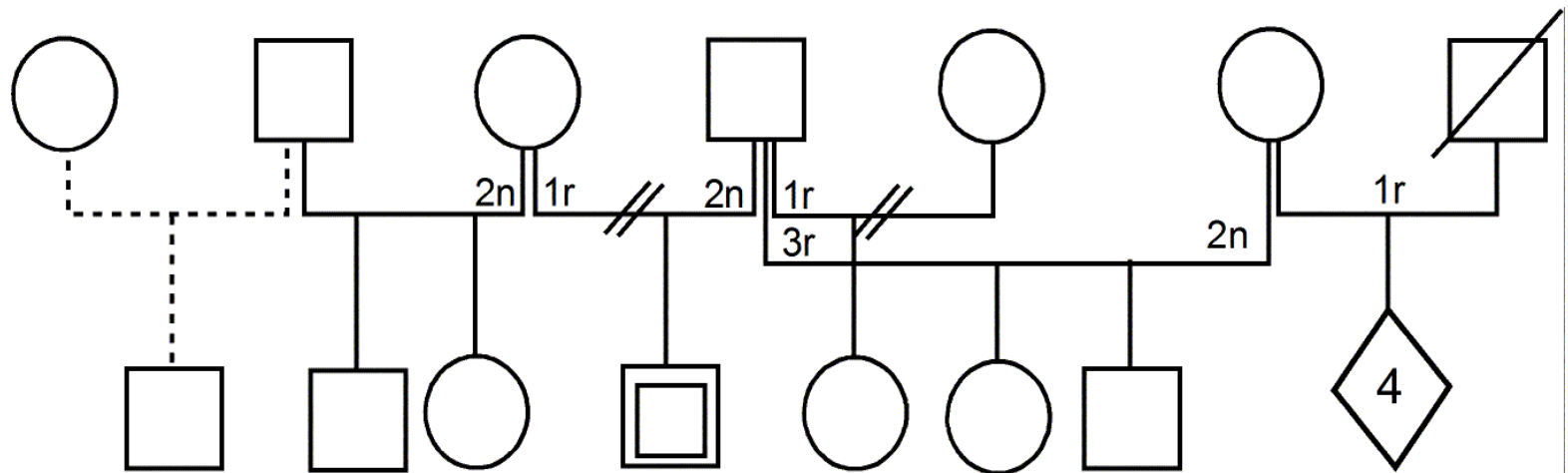

Relacions de filiació i parentiu (III)

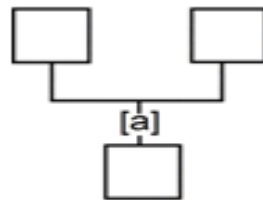
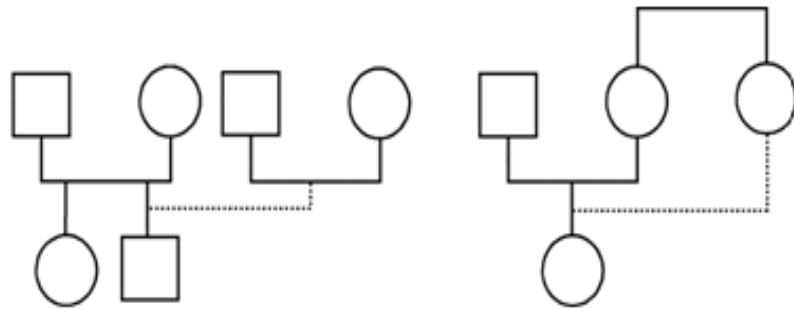

Residència, custòdia i acollida (I)

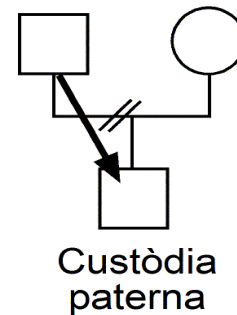
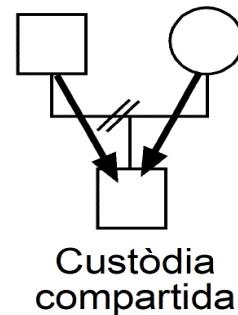
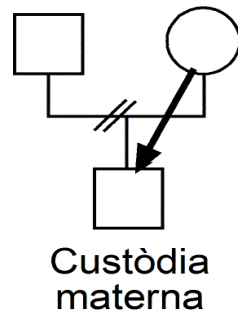
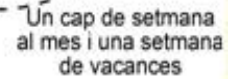
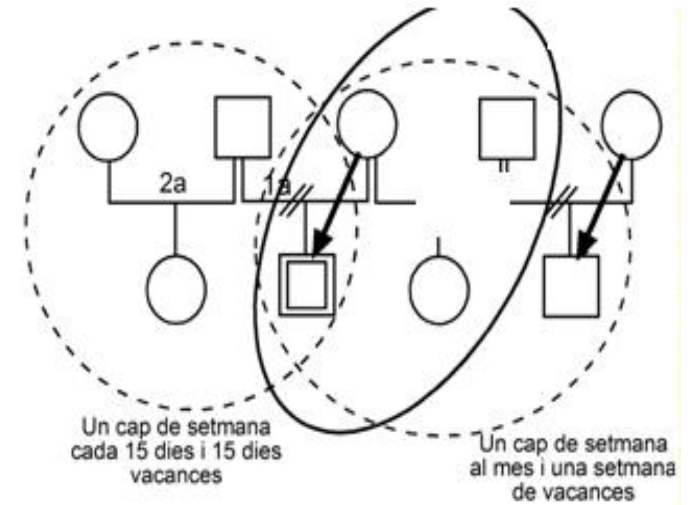
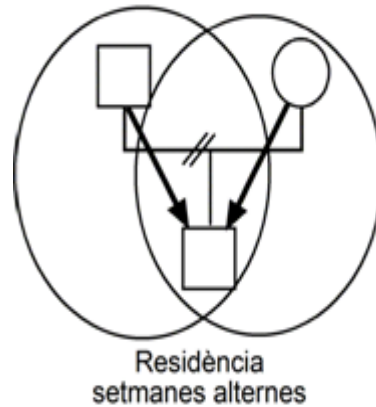
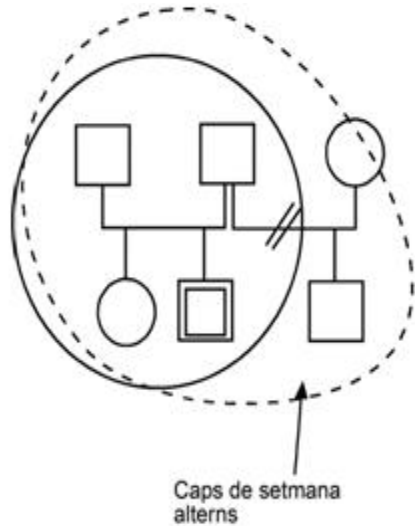

Residència, custòdia i acollida (II)

